



Company Profile







あなたのそばに。

Always nearby you.



# The Future by Ferrotec

I think this company's background is a rather unique one. We were established in Japan as a subsidiary of an American company in 1980, and became independent seven years later in 1987. We built a domestic factory and expanded into China in 1992. We took the company public in 1996, keeping that momentum through 1999 when we acquired our NASDAQ listed former parent company via a friendly take over bid. Twelve years had passed since becoming independent. The parent-child relationship had reversed, but by becoming "Ferrotec Group" once again, we were able to achieve dramatic growth. From April 2017, our company was renamed "Ferrotec Holdings Corporation", and shifted to a holding company structure. The sources of growth were applications of the company's core ferrofluid technologies, born from the Apollo Space program, and the topic of my master's thesis, thermoelectric modules.

Since that time, our offering has expanded and our portfolio has diversified. Ferrotec products are currently being utilized in a wide range of fields, such as, the electronics and automobile industries, household appliances, medical equipment, and photovoltaics. We will continue to strive to supply products that contribute to the society while being a company that helps to make the world a better place, a company that cares for the environment, and a company that continues to grow.

Representative Director, President & Group CEO

He Xian Han

Satisfaction for our Customers  
Earth Friendly and Environmentally Conscious  
Dreams and Vitality to our Society

With a global perspective, Ferrotec operates in harmony with international and local communities, acting in good faith as a company that provides products and services that contributes to people everyday's life.

Earning satisfaction and trust from our customers  
Contributing to solving global environmental problems  
Devoted to serving society through manufacturing.

A company that is conscious, improves,  
and pursues happiness. Ferrotec.



# Supporting Daily Life

Ferrotec's products support business and infrastructure in ways you can't see, and come in contact with your life in places you may not typically notice.

## Electronics Industry

Our products are used in the manufacturing process of smartphones, power saving and environmentally friendly LED. Products we now cannot live without in our daily life and business.



Final product example	Smartphone/ Personal Computer/ Flash Memory/ LED/ DVD
Ferrotec's product offering	Vacuum Seals/ Quartz/ Ceramics/ Silicon Parts/ CVD-SiC/ Silicon Wafers/ Deposition Apparatus

## Medical Equipment

In the developed countries of the world, Japan is the center of increased aging society, and we believe this will bring our company an expanded role in the medical field. Whether it is endoscope, blood analysis equipment, or inspection tools, in this field Ferrotec is active and will continue to grow.



Final product example	Endoscope/ Hemanalysis Device/ Magnetic Nanoparticles
Ferrotec's product offering	Ceramics/ Thermo-electric Modules/ Ferrofluid

## Photovoltaic Power Generation

Against the global-level backdrop of the COP21 Framework Convention on Climate Change, the use of photovoltaics is expected to expand. Ferrotec's products are integral to these solar panels, supporting people everyday's life.



Final product example	Residential solar panel/ Panel for mega-solar projects
Ferrotec's product offering	Silicon Ingots for Solar Cells/ Wafers for Solar Cells/

## Automotive Industry

In this era, when self-driving taxis are undergoing field testing, EV and hybrids, and GPS has become universal, we need to safely manage and teach these technologies. Ferrotec is always there to accompany fun driving and safe transportation of people.



Final product example	temperature control seats/ car audio/ car navigation/ power control power semiconductor
Ferrotec's product offering	Thermo-electric Modules/ Ferrofluid/ Power Semiconductor Substrate/ Thermistor

\* Thermistors are produced by our group company Ohizumi Mfg. Co., Ltd.

## Laundry Equipment

Tourists to Japan appreciate the high quality of linen products at Japan's hotels. Supporting this are Ferrotec's exceptionally automated, energy and resource-conserving industrial laundry equipment. Increasing needs for high quality linen in China and emerging countries are expected in the future. Ferrotec supports the behind-the-scenes work for comfortable hotel life.

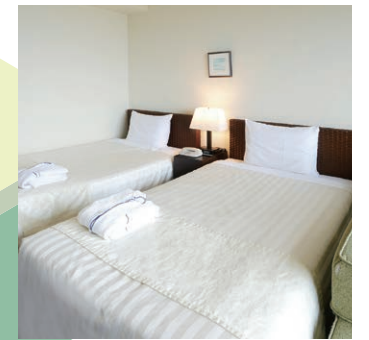

Final product example	Continuous washing machine/ Spin dryer/ Dryer/ Rolling machine etc.
-----------------------	---

\* Manufactured by group company, Asahi Seisakusho.

## Consumer Electronics

The IoT connects a variety of people, goods, and information on the internet, erasing the boundary between net products and consumer electronics, which will bring an era when consumer electronics will watch over and take care of people. At the forefront of this, Ferrotec is always there.



\* Incorporated into the final product, such as thermo-electric modules. There are also those used in the manufacturing process such like quartz and ceramics.

Final product example	LCD TVs/ Air Conditioners/ Wine Cellars/ Dryers/ Audio speakers
Ferrotec's product offering	Thermo-electric Modules/ Ferrofluid/ Power Semiconductor Substrate/ Thermistor



# Semiconductors that create the future Ferrotec supports these foundations

Semiconductors are manufactured through numerous processes. Ferrotec's technology and products have become indispensable in these manufacturing processes.

## IT Innovation moving at an accelerated pace

With IoT, Big Data, AI, 3D NAND and others, the environment surrounding semiconductors, including information and communication, is increasing at an accelerated pace. At Ferrotec, we are proactively promoting the creation of a system that will be ready for new demands.



## Products that respond to the latest technology trends

In order to answer future demand in semiconductors accompanying technological innovations, Ferrotec's semiconductor business covers numerous products that range from parts up to processing.



### Vacuum Seals

For semiconductors boasting high-performance and high-yield, it is important to secure an airtight space without impurities during the manufacturing process. Our company's equipment related products demonstrate their performance in many processes.

### Material Products

During the wafers manufacturing process, our material products are used as jigs and consumables in thin film production, transportation and cleaning processes.

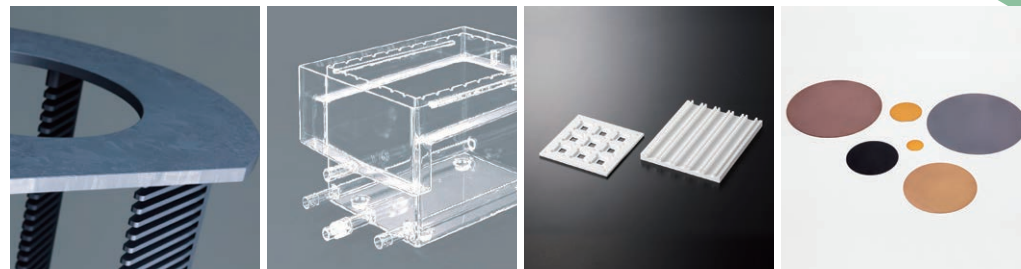

Silicon Parts    Quartz Products    Ceramics Products    SiC Parts (CVD-SiC)

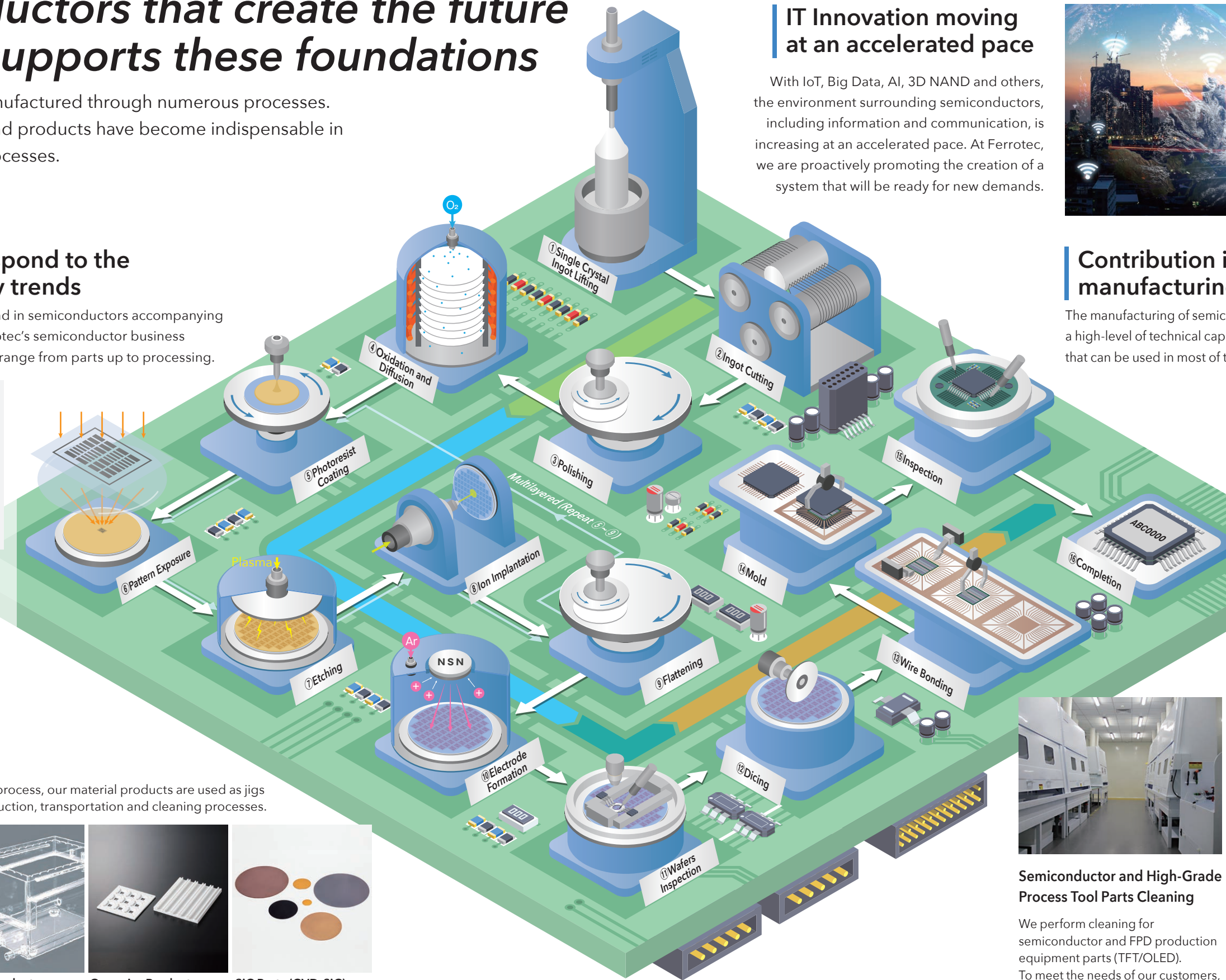

## Contribution in the semiconductor manufacturing process

The manufacturing of semiconductors is complicated and requires a high-level of technical capacity. At Ferrotec, we provide products that can be used in most of the manufacturing processes.



### Silicon Wafers Production

At our Chinese plant, we implement integrated manufacturing of silicon wafers from single crystals. Following small calibers of 6 inches or less, we will start the production of 8-inch wafers from FY2017.



### Semiconductor and High-Grade Process Tool Parts Cleaning

We perform cleaning for semiconductor and FPD production equipment parts (TFT/OLED). To meet the needs of our customers, we have the latest equipment that supports Sub-28nm Microstructure.



### Contract Manufacturing Service

In addition to the manufacturing of a variety of electric furnaces and assembly of deposition apparatus for the electronics industry, We also provide contract manufacturing service for any type of device.

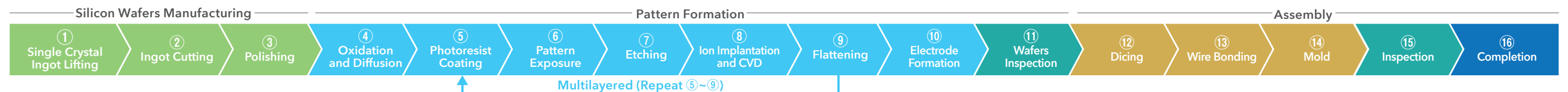



# Semiconductor Equipment-related Business

Semiconductor Equipment-related Business, we deal with products like manufacturing equipment for semiconductor, liquid crystal, organic EL and flat panel displays.

The main products we produce and supply are vacuum seals, an application of ferrofluid technology, and material products, essential to the manufacturing process of semiconductors. This segment of course supports state-of-the-art semiconductor technology for tablet PC's and smartphones, and in the future, wearable devices where growth is expected. We have the wealth of accumulated technology and the know-how necessary for mass-production.



## Quartz Products

### Ultra-High Purity Glass, Tough against Heat and Chemical Changes

The semiconductor manufacturing process involves frequent treatments of high heat and chemicals. Coming into play here are quartz products composed of ultra-high-purity silica glass. Whether it is in the thin film generation and diffusion process, or as jigs and consumables in the transport and cleaning process of wafers, our quartz products play an important role in the processing of increasingly thinning and high purification semiconductors.

**Examples of Products Used For:**  
LCD TV's, Smartphones, PC's, Flash memory, CPU's, LED  
\*Used in the manufacturing process

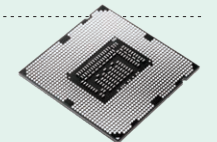

## Vacuum Seals



### Ensuring a Sealed Environment with no Contamination

The vacuum seals which use ferrofluid to enable transmission of rotational movement into the vacuum atmosphere are used in the manufacturing process of semiconductors, FPD, LED, and solar cells. They account for the company's core, and are used mainly in the etching and deposition processes of semiconductor wafers, as well as in the rotary mechanisms of delivery robots for FPD panels, isolating the sealed space from the outside, while precisely transmitting the necessary power for processing.

**Examples of Products Used For:**  
LCD TV's, Smartphones, PC's, Flash Memory, CPU's, LED  
\*Used in the manufacturing process



## Silicon Parts

### High-Purity Polysilicon Jigs used in Manufacturing Process

Our SiFusion™ product makes the manufacture of silicon jigs from ultrapure polysilicon possible for the first time, offering innovative solutions in the formation of the wafer and diffusion processes. It contributes to total cost saving for customers by achieving extended usage and improved operating rates in the diffusion process of reactive gas and reduced number of washes.

**Examples of Products Used For:**  
LCD TV's, Smartphones, PC's, Flash memory, CPU's, LED  
\*Used in the manufacturing process



## Contract Manufacturing and Assembly Service

Based on our metal processing technology cultivated in vacuum seals, we developed a contract manufacturing and assembly business for large-format equipment

Contract Manufacturing Service: In Hangzhou, Changshan, and Shanghai, China, a wide range of components are processed and contract production and assembly of equipment is done based on Ferrotec's precision machining and equipment assembly technologies.

Responsible for contract processing of precision metal parts (from small to large), contract assembly of units and equipment, local procurement support, equipment installation and start-up. For Semiconductors, FPDs (OLED/LCD), and other industrial fields.

\*In April 2023, 'Cosmo Science Co., Ltd.' has joined our company group to expand its business in the contract manufacturing of semiconductor production equipment and FPD manufacturing equipment.

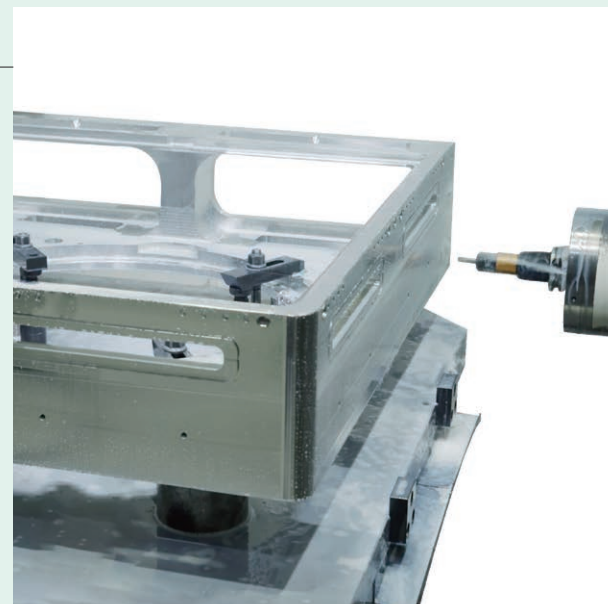

## SiC Parts (CVD-SiC)

### Ultra-High Purity, High Heat Resistance and High Wear Resistance Silicon Carbide Products from Original CVD Production Method

Our SiC products are a one to one compound of silicon (Si) and carbon (C), ultrapure and highly resistant to wear, heat, and corrosion. They are used widely in the manufacturing of semiconductors as wafer boats and tubes, and silicon wafer replacement dummy wafers, as jigs used at high temperatures.

**Examples of Products Used For:**  
LCD TV's, Smartphones, PC's, Flash memory, CPU's, LED  
\*Used in the manufacturing process







## Ceramics Products

### Highly Strong and Pure Ceramics Supporting State-of-the-Art Processing Technology

We have achieved integrated production of fine ceramics and machinable ceramics that leverage advanced material technology, production technology, and precision processing technology under the strictest quality controlled conditions. Our ceramic products are widely adopted as high quality parts suited for the manufacturing process of semiconductors, which require high grades of purity, rigidity and precision.

#### Examples of Products Used For:

LCD TV's, Smartphones, PC's, Flash memory, CPU's, LED

\*Used in the manufacturing process Surgical endoscope

\* Used in the product



## Vacuum Coating System

### US-made Temescal Vacuum Coating Systems

High-performance e-beam guns and high-voltage power supply at the heart of Temescal devices offer a wide array of equipment from bell jar systems for universities, research laboratories, and small-scale manufacturing, to high throughput systems for large-scale manufacturing. As a global standard machine in compound semiconductors, they have been adopted by many customers, and are progressively being introduced in the manufacturing of LED's and communication chips.

#### Examples of Products Used For:

Smartphones, LED, HDD

\*Used in the manufacturing process

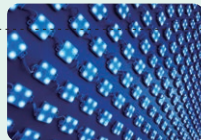

## Quartz Crucibles

### A clean, excellently heat-resistant, high-purity quartz crucible

Clean, heat resistant, pure quartz is indispensable for semiconductor manufacturing processes. These same high purity quartz crucibles are used as substrate containers for raw single-crystal Si material. Ferrotec provides its quartz products to manufacturers for the process of single-crystal Si applications including semiconductor and solar cell..



## Process Tools Parts Cleaning

### Precision Cleaning of Semiconductor and FPD Process Parts

We provide parts cleaning services for semiconductor and FPD manufacturing equipment.

We meet our customers' needs with our state-of-the-art equipment, including sand blasters, plasma spraying equipment, and alumite treatment equipment, in addition to chemical cleaning and pure water cleaning.

## Reclaim Wafers

### Reclaim wafer service based on Ferrotec's prime wafer processing and process tools parts cleaning technologies

For many years, we have had an integrated system for processing single-crystal ingots into semiconductor wafers, and have maintained the largest market share in the process tools parts cleaning business in China. On the basis of these polishing and cleaning technologies, as well as our network of customers, we have developed a reclaim wafer service to meet customer needs associated with increased domestic production in China.



## Silicon Wafers

### Integrated Production from the Single-Crystal Ingot

We have an integrated system for processing single-crystal ingots into semiconductor wafers for small diameter silicon wafers up to 6 inches, as well as 8 and 12-inch wafers.

We have established a global supply system focusing on mass production of polished, annealed, and epitaxial wafers.

Equity method affiliate

## SiC Wafers

### Advanced technology for electric vehicles and other next-generation applications: SiC (silicon carbide) single-crystal wafers

Building on the strengths of our defect control technology cultivated in the semiconductor silicon (Si) single-crystal business, our equipment manufacturing technology, and our SiC expertise and customer base gained through the CVD-SiC business (jigs for semiconductor manufacturing equipment), we are engaged in the development and manufacture of SiC (silicon carbide) single crystal ingots and wafers in a joint venture with China's top SiC research institutes. (trial production is scheduled to start in 2021).

Equity method affiliate

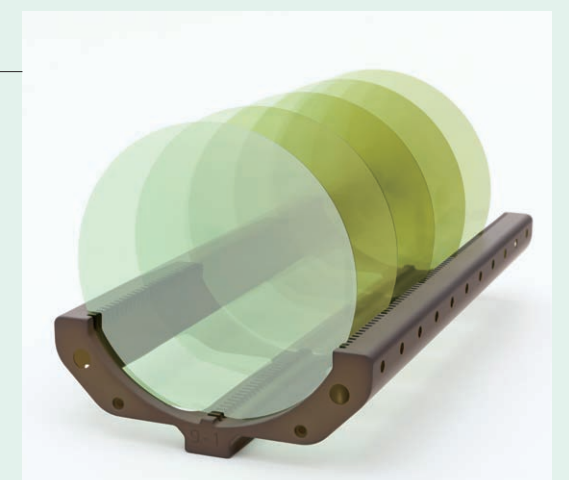



# Electronic Device Business

In the electronic device business, there are the core technologies of Ferrotec—ferrofluid and thermo-electric modules, also known as Peltier cooling devices. Ferrofluid is used inside vacuum seals, utilized for wafer transfer robots, and installed in clean room equipment to prevent the intrusion of dust. Because thermo-electric modules act as a heat pump that transfers heat when an electrical current flows, they are used as a material to maintain and manage temperature for electronics. Capable of reaching temperatures from minus 20°C—equal to that of a freezer—to easily surpassing the boiling point of 100°C, our products are utilized in a wide range of fields, from medical equipment, semiconductors, and the telecommunication industry.

## Thermo-Electric Modules

**By passing a direct current and resulting into thermo amplitude, here is the Temperature Control Semiconductor (Peltier Elements)**

Thermo-electric modules are plate-like semiconductor cooling devices that work by using the movement of heat when a current flows through the junction of two different metals. Compact, lightweight, and Freon-free, they are used in temperature control seats of automobiles, cooling chillers, optical communications, biotechnology, air conditioners, dryers and a variety of consumer electronic products.

**Examples of Products Used For:**  
Climate Control Seats for Automobiles, Car Navigation, Air Conditioners, Small Refrigerators, Shavers, Dryers  
\*Used in these products

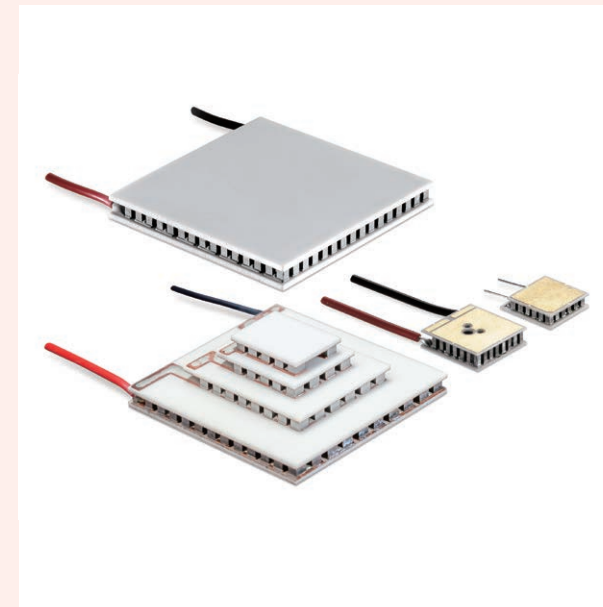
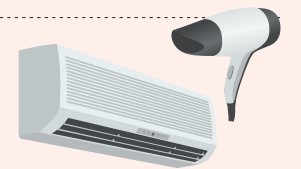

## Ferrofluid

### A Mysterious Liquid with Magnetic Attraction

While being a fluid, it is a functional material attracted to magnets and magnetized by external magnetic fields. In the 1960's NASA Space Program, it was developed to transport fuel in zero gravity. Currently it is used in speakers, actuators, sensors, recycling separation applications, and also in Vacuum seals—one of our company's core products.

**Examples of Products Used For:**  
Car Audio, TV Speakers, Magnetic Nanoparticles  
\*Used in these products



## Chillers

**By cooling or heating a circulating liquid to the set temperature, this system ensures that equipment and devices are maintained at a consistent temperature**

A chiller (constant-temperature water circulator) is a device that supplies a circulating liquid such as water while cooling/heating to a preset temperature.

It is used to keep an object at a constant temperature such as heat sources in facilities and equipment via temperature-controlled circulating water.



## Thermistor

### Semiconductor ceramic sensitive to temperature changes

Thermistor is a semiconductor ceramic that exhibits extremely large changes in resistance with temperature changes. This characteristic makes the thermistor an ideal temperature sensor that is widely used in areas such as in-vehicle technology, home appliances, and optical communication, and its demand is expanding with the increase in vehicle electrification and digitization. As a niche leader in the thermistor market, Ohizumi Mfg. supplies high quality thermistors to global Tier 1 companies.

\* The term "thermistor" is derived from "thermally sensitive resistor".



## Power Semiconductor DCB & AMB & DPC Substrates

### Application of Thermo-electric module Manufacturing Technology for Heat Dissipation and Insulation Substrate

We manufacture power semiconductor substrates, which are heat-dissipating insulating substrates for power device products. We manufacture DCB substrates\*1 made of alumina ceramics, which are mainly used in industrial equipment and home appliance inverters, and AMB substrates\*2 made of silicon nitride and aluminum nitride, which are mainly used in high-power applications such as automobiles and trains. In the future, we will also start mass production of highly heat-resistant and high-strength DPC substrates\*3, which are made of metalized alumina ceramics, for use in optical communications and power LEDs.

- \*1: DCB=Direct Copper Bonding
- \*2: AMB=Active Metal Brazing
- \*3: DPC=Direct Plated Copper

**Examples of Products Used For:**  
Electric Vehicles, Machining Tools, Servers  
\*Used in these products

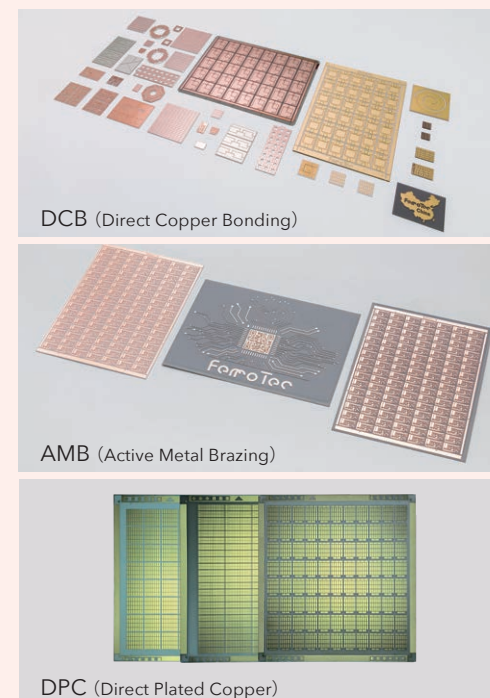



# Other-related Business

In addition to the products from its mainstay semiconductor equipment-related business and electronic device business, the Ferrotec Group is also engaged in a range of OEM businesses, including commercial washing machines for the linen industry, woodworking and metal cutting tools, and wafers used in solar cells. These products are integrated into the supply chains of their respective industry sectors and delivered to customers around the world by taking advantage of the network of affiliates and business relations both inside and outside Japan and China.



## Solar Cell Related Business

## Total Solutions from Ingots to Cells

### Ingots for Solar Cells

Raw silicon material is melted at high temperatures, then gradually cooled to generate crystallized ingots. In addition to single-crystal ingots with excellent regular atom arrangement and power generation performance, our in-house production equipment enables a stable supply of superior economic and production efficient multi-crystal ingots.



### Wafers for Solar Cells

We produce single-crystal wafers by using a fixed abrasive grain wire saw to cut thin slices from ingots. Our wafers correspond to thinning wires, and are adopted in high conversion efficiency modules.

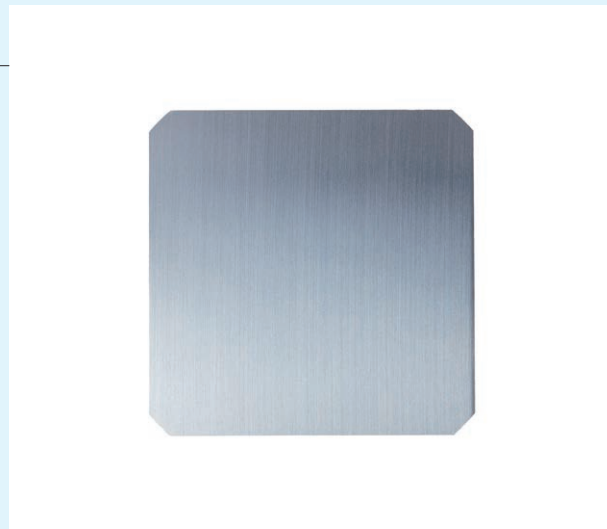

## Industrial Cleaning Equipment

### Industrial Cleaning

Asahi Seisakusho Co., Ltd. maximizes consumption efficiency and provides economical and environmentally friendly products by not only cleaning and reusing materials without throwing them away but also recycling water and heat. The industrial cleaning equipment with the world's highest hygiene level is widely used everywhere; for example, in cleaning plants, hospital facilities, and hotels.



## Machine Blade

### Industrial Knife

Tokyo Knife Co., Ltd. manufactures industrial knives used in a variety of manufacturing processes, including for smartphone electronic parts, automobiles, and cardboard. Taking advantage of its technologies and quality that have been honed since 1925, the company meets customers' needs by offering industrial knives that can cut all types of materials in information technology, iron and steel, paper, wood, food, and other industries.



### Wood Processing / Metalworking Sawblade

Hangzhou Wagen Precision Tooling Co., Ltd. develops, produces, and distributes precision cutting tools, such as a variety of saw blades, including cold, aluminum alloy, hard alloy, and diamond saw blades, under the WAGEN brand. The tools are widely used in industries for a broad range of applications, including automotive and aircraft components manufacturing, aluminum alloy die casting, furniture manufacturing, wood processing, and organic glass processing.





# Eyes on the World

Ferrotec Group has developed a "Spirit of Craftsmanship" as a manufacturer all across the world. The United States' marketing and R&D expertise, Japan's industrial technology, China's development of mass production, Europe's own unique development capabilities, and the expanding technology infrastructure of Asia. In anticipation of production and sales, we have placed bases taking root around the globe. We are truly a transnational company.

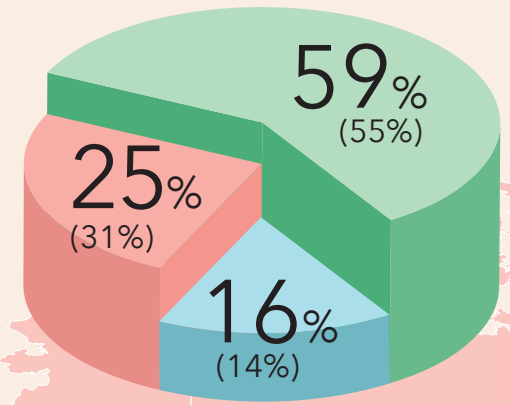

## Consolidated Net Sales

- **Asia** 130,927 (Millions of yen)
- **Japan** 35,673 (Millions of yen)
- **Europe and America** 55,830 (Millions of yen)

2023 3rd Quarter Total Sales

**222.4billion yen**  
(Last year sales 210.8billion yen)

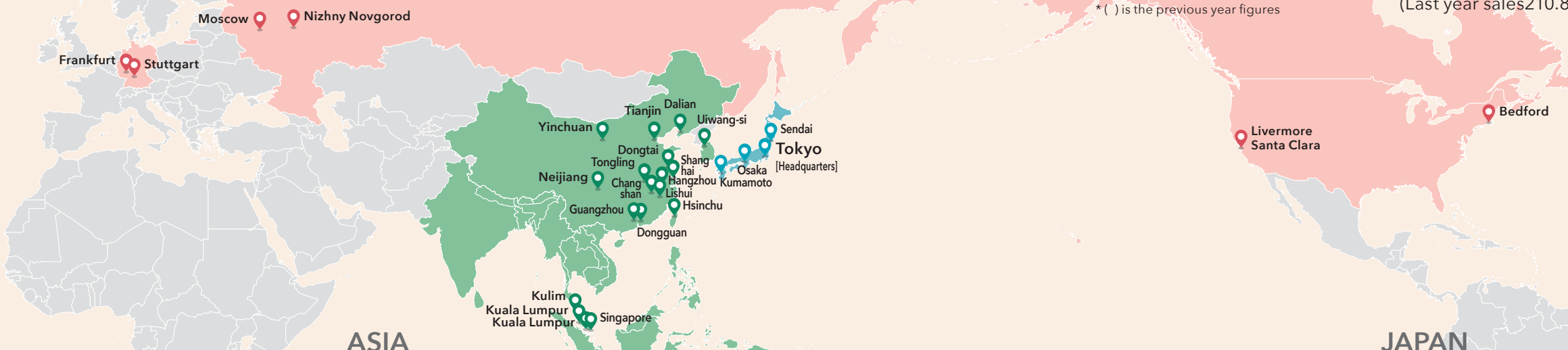

## EUROPE

📍 **Frankfurt (Germany)** 🏢



📍 **Stuttgart (Germany)** 🏢

Products: Electron Beam Guns  
(Vapor deposition apparatus for electronic gun)

📍 **Moscow (Russia)** 🏢

Products:  
Thermo-electric modules



📍 **Nizhny Novgorod (Russia)** 🏢

Products: Micro-electric module

## ASIA

📍 **Hangzhou** 🏢

Products: Thermo-electric module (Assembly), Vacuum Seals, Quartz, Fine Ceramics, Silicon Parts, Contract Manufacturing, Saw Blades, Semiconductor Wafers



📍 **Shanghai** 🏢

Products: Thermo-electric modules (Material), Power Semiconductor Substrate, Semiconductor Wafers, Wafers for Semiconductor, Solar Cell Manufacturing Equipment, Cleaning, Surface Treatment



📍 **Yinchuan** 🏢

Products:  
Quartz Crucibles for Semiconductors, Semiconductor Ingots, Silicon Parts Ingots



📍 **Tongling** 🏢 Products: Cleaning, Reclaim Wafer, SiC Wafer

📍 **Dongtai** 🏢 Products: Power Semiconductor Substrate, Quartz

📍 **Changshan** 🏢 Products: Quartz, Thermo-Electric Modules, CMS, Fine Ceramics, CVD-SiC, Silicon Parts

📍 **Lishui** 🏢 Products: Semiconductor Wafers, Epitaxial Wafer, Thermistor

📍 **Tianjin** 🏢 Products: Cleaning

📍 **Neijiang** 🏢 Products: Cleaning

📍 **Dalian** 🏢 Products: Cleaning

📍 **Guangzhou** 🏢 Products: Cleaning

📍 **Dongguan** 🏢 Products: Thermistor

📍 **Hsinchu (Taiwan)** 🏢



📍 **Singapore** 🏢



📍 **Kuala Lumpur (Malaysia)** 🏢



📍 **Kulim (Malaysia)** 🏢

Product: Quartz, Ceramics, Contract Manufacturing, Robot Assembly

📍 **Johor Bahru (Malaysia)** 🏢 Products: Power Semiconductor Substrate

📍 **Uiwang-si (South Korea)** 🏢



## JAPAN

📍 **Tokyo [Headquarters]** 🏢

Products:  
Vacuum Seals, Ferrofluid (Chiba)  
Fine Ceramics (Hyogo/ Ishikawa)  
CVD-SiC (Okayama)  
Industrial Equipment (Kanagawa)  
Quartz (Yamagata)  
Thermistor (Saitama/ Aomori)  
Industrial Knife (Miyagi)



📍 **Osaka** 🏢

📍 **Sendai** 🏢

📍 **Kumamoto** 🏢

## AMERICA

📍 **Bedford, NT** 🏢

Products:  
Vacuum Seals, Ferrofluid



📍 **Livermore** 🏢

Products:  
Vacuum Coating System



📍 **Santa Clara, CA** 🏢

👤 Sales Offices    🏢 Production Bases



# Honing our Technology, Connecting the Future

Without constantly improving our technology, we could not survive in the quickly innovating industry of electronics, which deals with semiconductors. The same goes for manufacturing, where day-to-day effort is required to connect to the next generation. M&A is also regarded as a powerful option for acquiring new technologies and expanding business.

1980      1985      1990      1995      2000      2005      2010      2015      2020      2025

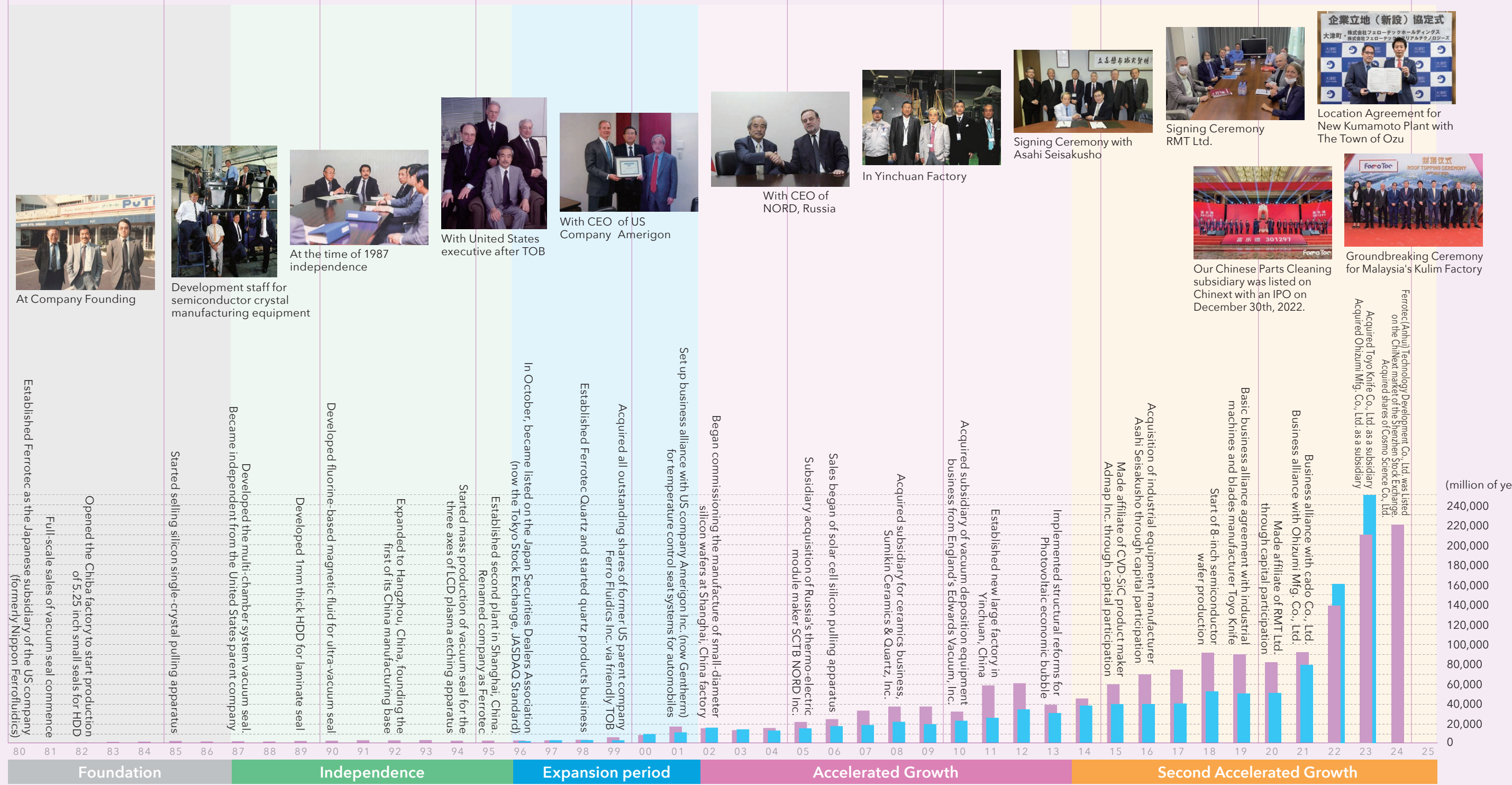

At Company Founding

Development staff for semiconductor crystal manufacturing equipment

At the time of 1987 independence

With United States executive after TOB

With CEO of US Company Amerigon

With CEO of NORD, Russia

In Yinchuan Factory

Signing Ceremony with Asahi Seisakusho

Signing Ceremony RMT Ltd.

Location Agreement for New Kumamoto Plant with The Town of Ozu

Our Chinese Parts Cleaning subsidiary was listed on Chinext with an IPO on December 30th, 2022.

Groundbreaking Ceremony for Malaysia's Kulim Factory

Established Ferrotec as the Japanese subsidiary of the US company (formerly Nippon Ferrofluidics)

Opened the Chiba factory to start production of 5.25 inch small seals for HDD

Full-scale sales of vacuum seal commence

Developed the multi-chamber system vacuum seal.

Became independent from the United States parent company

Started selling silicon single-crystal pulling apparatus

Developed 1mm thick HDD for laminate seal

Developed fluorine-based magnetic fluid for ultra-vacuum seal

Expanded to Hangzhou, China, founding the first of its China manufacturing base

Started mass production of vacuum seal for the three axes of LCD plasma etching apparatus

Established second plant in Shanghai, China. Renamed company as Ferrotec

In October, became listed on the Japan Securities Dealers Association (now the Tokyo Stock Exchange, JASDAQ Standard)

Established Ferrotec Quartz and started quartz products business

Acquired all outstanding shares of former US parent company Ferro Fluidics Inc. via friendly TOB

Set up business alliance with US company Amerigon Inc. (now Gentherm) for temperature control seat systems for automobiles

Began commissioning the manufacture of small-diameter silicon wafers at Shanghai, China factory

Acquired subsidiary for ceramics business, Sumitkn Ceramics & Quartz, Inc.

Sales began of solar cell silicon pulling apparatus

Subsidiary acquisition of Russia's thermo-electric module maker SCTB NORD Inc.

Acquired subsidiary of vacuum deposition equipment business from England's Edwards Vacuum, Inc.

Established new large factory in Yinchuan, China

Implemented structural reforms for Photovoltaic economic bubble

Acquisition of industrial equipment manufacturer Asahi Seisakusho through capital participation

Made affiliate of CVD-SiC product maker Admap Inc. through capital participation

Basic business alliance agreement with industrial machines and blades manufacturer Toyo Knife

Start of 8-inch semiconductor wafer production

Business alliance with cadco Co., Ltd.

Made affiliate of RMT Ltd. through capital participation

Business alliance with Ohizumi Mfg. Co., Ltd.

Acquired Toyo Knife Co., Ltd. as a subsidiary

Acquired Ohizumi Mfg. Co., Ltd. as a subsidiary

Ferrotec (Arhui) Technology Development Co., Ltd. was listed on the Chinext market of the Shenzhen Stock Exchange.

Acquired shares of Cosmo Science Co., Ltd.

1980-1986 (Founding and Market Involvement)      1987-1995 (Began Operations in China)      1996-2001 (M&A Continuation)      2002-2013 (Chinese Market)      2014- (Global Market)

■ Trends in Consolidated Sales      ■ Changes in consolidated total equity



# The Joy of Growth



41 years have passed since our founding. We have overcome many peaks and valleys of the business environment such as the IT bubble and the economic downturn from the collapse of Lehman Brothers, to become the Ferrotec of today. We will continue to be a company in which our stakeholders can enjoy enduring growth.

## Segments

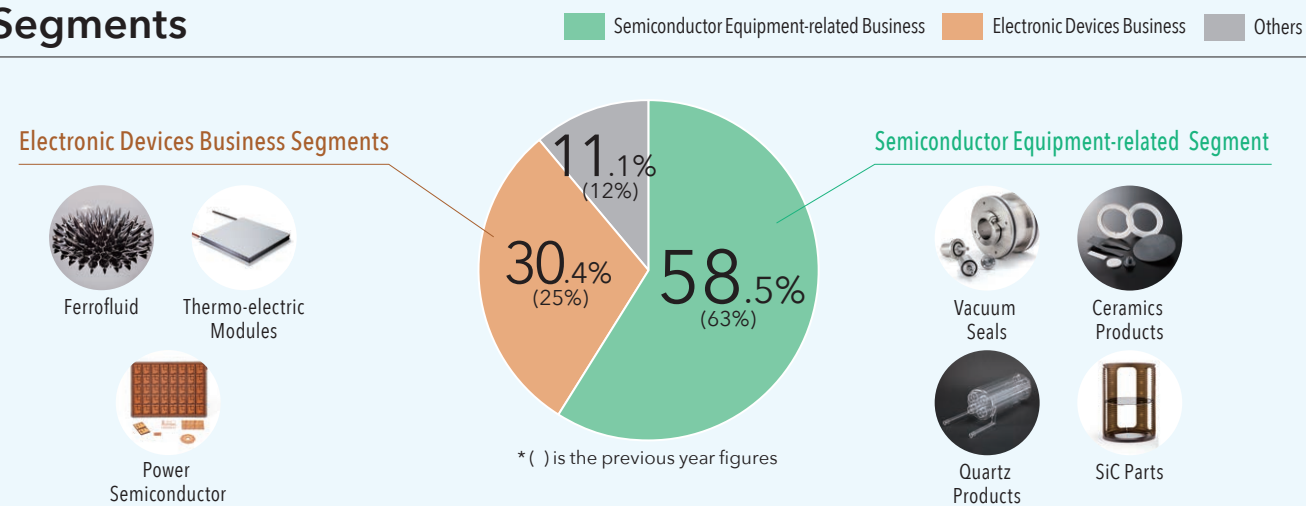

## Trends in sales by segment

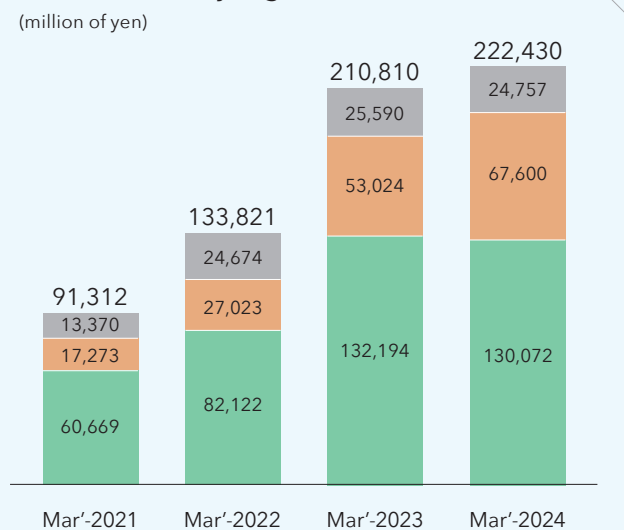

## Operating profit ratio by segment

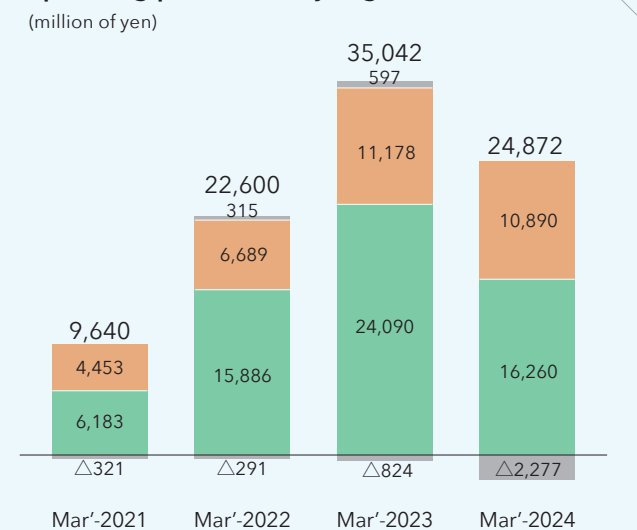

## Financial Highlights

### Sales/ Ordinary income

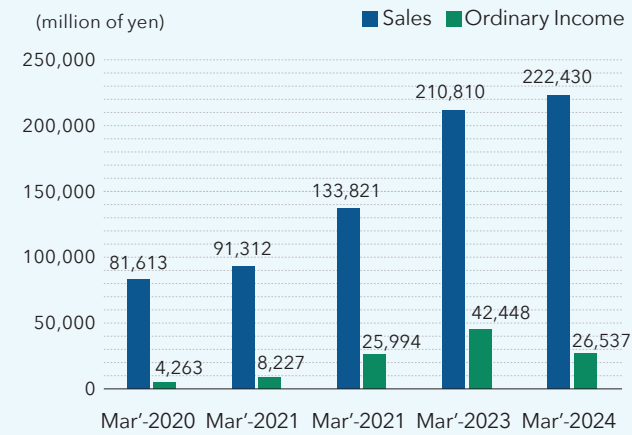

### Total Assets/ Total net assets

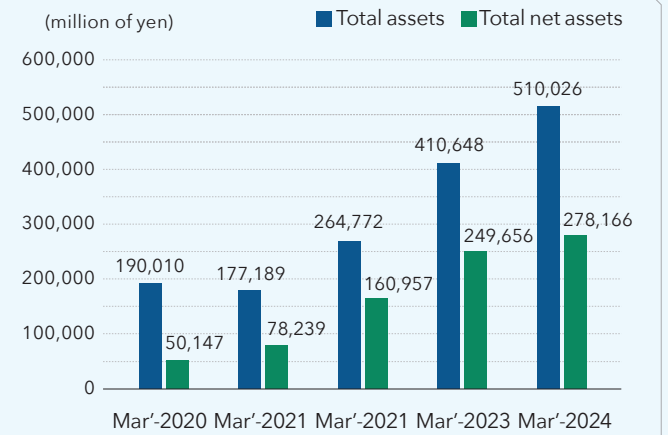

### Net income per share

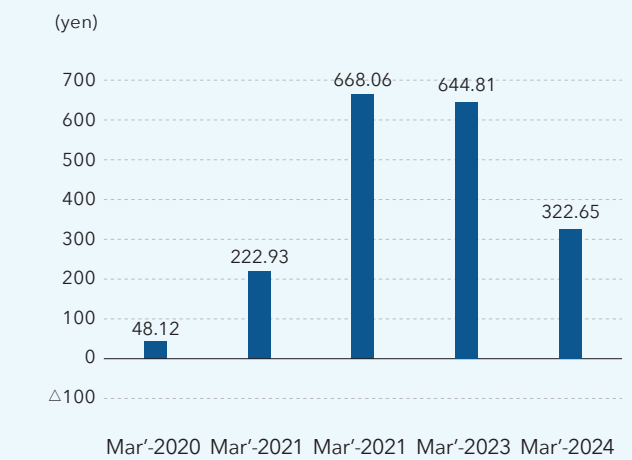

### ROE (return on equity) / ROA (return on assets)

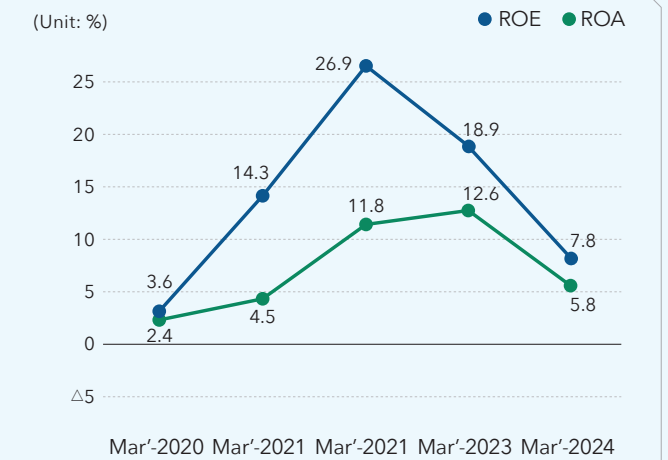

## Company Profile

<b>Trade name</b>	Ferrotec Holdings Corporation
<b>Founded</b>	September 27, 1980
<b>Head Office</b>	Nihonbashi Plaza Building 5F, 2-3-4 Nihonbashi, Chuo-ku, Tokyo 103-0027
<b>JASDAQ Standard</b>	JASDAQ, October 18, 1996 (Stock code: 6890) Current : TSE Standard Market.
<b>Representative</b>	CEO He Xian Han
<b>Business Description</b>	Management of group companies and R&D
<b>Capital</b>	29,539,924,302 yen
<b>Shares Issued</b>	47,012,202 shares (Including 94,305 shares of treasury stock)
<b>Affiliated Companies</b>	[Consolidated Subsidiaries] 73 companies [Equity Method Subsidiaries] 12 companies
<b>Employees</b>	[Consolidated] 14,192 [Nonconsolidated] 66

### Group company business

Semiconductor Equipment-related Business: vacuum seal, Metalworking, quartz products, ceramics products, silicon products, SiC products, process tools parts cleaning, reclaim wafers, quartz crucibles, (Equity method affiliate) silicon wafers, SiC wafers

Electronic Device Business: thermo-electric modules, ferrofluid, power semiconductor substrate, Thermistor

\* Others Laundry equipment and other related industrial equipment, silicon for solar cells, Industrial knife

See here for more information about financial data  
[https://www.ferrotec.co.jp/en/ir/ir\\_finance\\_data.php](https://www.ferrotec.co.jp/en/ir/ir_finance_data.php)

